

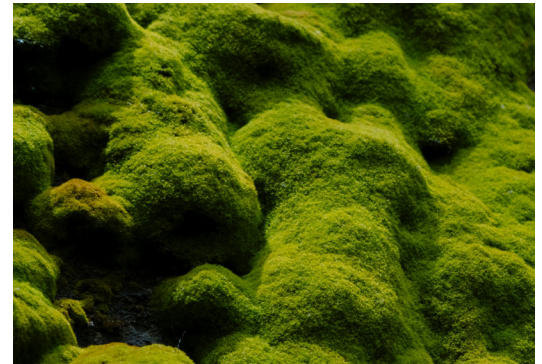

PRESERVED MOSS
PATTERNA
SUR-PFL-052



Experience Harmony...

Patterna manifests as an orchestration of rhythm and contrast, where shifting tones and textures converge into a singular harmony. Its surface compels the eye to move, to search, to linger – revealing moments of tension and release that echo the cadences of music and the geometries of nature.

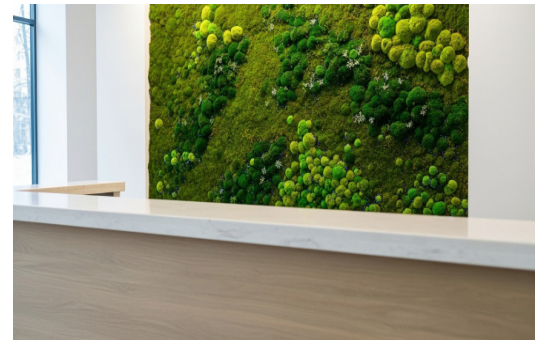





Why Preserved Moss?

Preserved moss walls bring the richness of nature indoors while performing as natural acoustic absorbers. With no need for watering, light, or trimming, they deliver lasting greenery at minimal cost. Their porous texture softens sound and improves comfort, while their preserved state ensures long-term sustainability by eliminating ongoing resource use.

<p>PRESERVED FROM NATURAL STATE</p>  <p>It captures the rich, lifelike texture and vibrant tones of live moss, yet it remains beautifully stable</p> <ul style="list-style-type: none"> + Stability and Longevity + Natural Aesthetic + It retains its appearance for years if kept dry and away from direct sun. 	<p>TACTILE</p>  <p>Soft, velvety, and natural to the touch — inviting a sensory connection with nature indoors.</p> <ul style="list-style-type: none"> + Authentic Texture + Comforting touch + Durable Feel 	<p>ACOUSTIC</p>  <p>The organic, fibrous structure of helps diffuse and absorb ambient noise.</p> <ul style="list-style-type: none"> + Sound Absorption + Acoustic Comfort + Biophilic Acoustics 	<p>SUSTAINABLE</p>  <p>Aligns with Sustainable Design Frameworks</p> <ul style="list-style-type: none"> + Resource Efficient + Eco-Friendly Sourcing + LEED and WELL Contributions
<p>MAINTENANCE FREE</p>  <p>Delivering a Lush, Natural Aesthetic, eliminating operational Cost and Complexity.</p> <ul style="list-style-type: none"> + Zero Irrigation + Sunlight Independent + Low OPEX Advantage 	<p>LEED POINTS</p> <p>+4</p> <p>By being Maintenance-Free, Resource-Efficient and Biophilic, supports LEED v4 credit Pathways</p> <ul style="list-style-type: none"> + Low-emitting Materials + Sourcing of Raw Materials + IEQ (Indoor Environmental Quality) + SS Sustainable Sites 	<p>FIRE RESISTANCE</p>  <p>Added fire-resistant treatments, they complies with interior building codes, ensuring that biophilic design does not compromise safety.</p> <ul style="list-style-type: none"> + Tested and Certified + Safety Integration + Design Confidence 	<p>EXPERIENTIAL</p>  <p>Attachment solution using physical hardware to attach to an existing surface or substrate.</p> <ul style="list-style-type: none"> + Multi-Sensory Engagement + Emotional Resonance + Place-Making Power

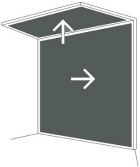
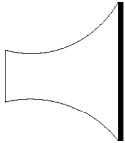
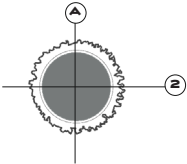
Multiple Spatial Possibilities

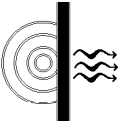
Preserved moss walls bring the richness of nature indoors while performing as natural acoustic absorbers. With no need for watering, light, or trimming, they deliver lasting greenery at minimal cost. Their porous texture softens sound and improves comfort, while their preserved state ensures long-term sustainability by eliminating ongoing resource use.

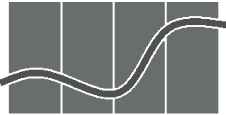
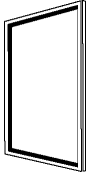
<p>CEILING AND WALLS</p>  <p>As architecture specialties, moss adds texture, calm, and acoustic comfort</p> <ul style="list-style-type: none"> + Specialty wall finishes with acoustic absorption + Distinctive overhead finish for spatial identity 	<p>CURVED SUBSTRATES</p>  <p>Flexible specialty finish that combines organic texture with spatial fluidity.</p> <ul style="list-style-type: none"> + Flex-mounting systems for concave/convex forms + Creates sculptural surfaces that enhance spatial identity and user experience 	<p>COLUMN WRAP</p>  <p>Preserved moss column wraps turn structural elements into living-like design features</p> <ul style="list-style-type: none"> + Seamless 360° coverage with natural texture + Enhances wayfinding and spatial rhythm with organic presence 	<p>LIGHTING INTEGRATION</p>  <p>Elevates surfaces into immersive architectural features.</p> <ul style="list-style-type: none"> + Enhances depth, shadow, and texture + Compatible with LV and specialty LED systems
<p>ACOUSTIC BUFFERS</p>  <p>As panels are mounted, gaps or coves are detailed to optimize noise absorption</p> <ul style="list-style-type: none"> + Airspace behind, enhances absorption through depth and resonance. + Reveals between panels act as sound traps, diffusing and buffering noise 	<p>SIGNAGE</p>  <p>Turns branding and into living-like architectural features, combining identity with biophilic presence.</p> <ul style="list-style-type: none"> + Cut-Out Lettering + Lighting & Depth Integration + Enhances visibility while emphasizing moss texture. 	<p>WOOD & METAL BEAVEL INTEGRATION</p>  <p>Bevel frames natural textures with architectural sharpness, creating refined transitions and functional edges.</p> <ul style="list-style-type: none"> + Crisp durable edges and transitions + Functional Detailing 	<p>FRAMING</p>  <ul style="list-style-type: none"> + Wood framing paired with preserved moss transforms installations into architectural art pieces + Architectural borders + Durability and Craft

Care Guidelines

Nature – beautifully preserved, effortlessly maintained.

Plantscape Preserved Moss is a 100% natural material, carefully preserved to retain its color, softness, and organic texture – without watering, trimming, or ongoing maintenance. With proper indoor conditions, your moss installation will remain beautiful for years

How Preserved Moss Performs

+ No Water Required

Preserved moss is not alive and should never be watered or misted.

+ Comfortable Indoor Environments

+ Indoor Use Only

Designed exclusively for interior applications, away from exterior exposure.

Touch and Interaction

- + Enjoy visually – avoid frequent handling
- + Natural oils from hands may affect texture and coloration over time

Temperature

+ Recommended range: 60°F – 77°F
(15°C – 25°C)

+ Avoid prolonged exposure to:

- + Extreme heat
- + Freezing conditions
- + Direct heat sources (heaters, fire places, mechanical rooms)

Humidity

+ Ideal relative humidity: 50% – 55%

Conditions to avoid:

- + **Low humidity** (below 40%) – may cause moss to feel dry or brittle
- + **High humidity** (above 60%) – may lead to softness loss, dye migration, or mold risk

Best Practice

Preserved moss performs best in spaces that feel comfortable to people. If a space is comfortable for occupants, it is generally ideal for preserved moss

Designed for Lasting Beauty

Preserved moss offers the look and feel of nature, without the maintenance of living plants – making it ideal for workplaces, hospitality, healthcare, and residential interiors seeking calm, biophilic design.

Preserved Moss Materiality Options and Understanding

Reindeer Moss - PMC#RD01LG

Preserved Reindeer Moss combines natural beauty, acoustic benefits, and sustainability for modern interiors. Its soft texture and vibrant colors evoke Nordic landscapes while remaining maintenance-free. Responsibly harvested and eco-preserved, it supports green-building goals and offers a timeless biophilic aesthetic without the upkeep of living walls

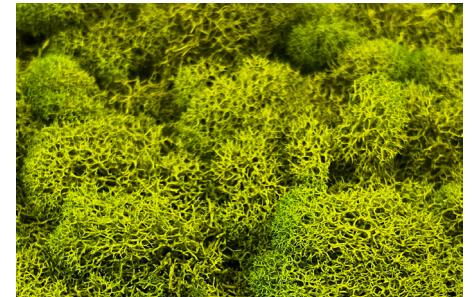

Preserved Moss Materiality Options

Pole Moss - PMC#PL01LG

A Preserved Pole Moss panel creates a sculptural focal point with rounded, cushion-like forms that add depth, texture, and shadow play. Beyond its bold visual impact, it enhances acoustics, making it ideal for reception areas, hospitality spaces, and branded interiors that celebrate nature's sculptural beauty



Preserved Moss Materiality Options

Sheet Moss - PMC#ST01GR

A Preserved Sheet Moss panel offers a smooth, velvety surface that evokes the forest floor with subtle tonal depth. Its continuous texture creates a serene, timeless backdrop while enhancing acoustics. Ideal for minimalist feature walls or refined settings, it delivers understated elegance and biophilic presence.

.....



Preserved Moss Materiality Options

Mood Moss - PMC#LG01GR

A Preserved Mood Moss panel adds dramatic depth and softness with its rich, dimensional texture. Both visually striking and acoustically effective, it creates a bold biophilic statement – ideal for hospitality, wellness, or corporate feature walls where atmosphere and impact matter



Inspiration



Dimensions

Standard Unit Dimensions

Typical ranges for height and width.

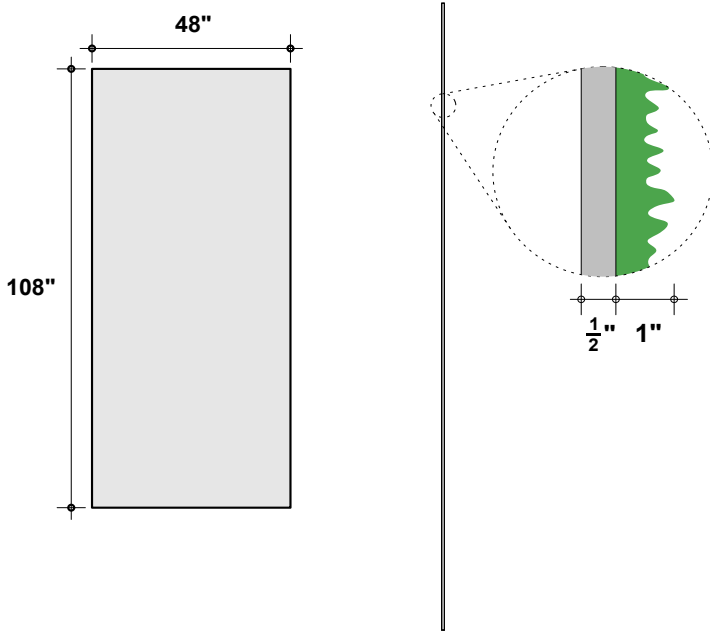

Custom Opportunity

Product dimensions can be manipulated in order to fit your design aesthetic and site conditions.

Standard Unit Thicknesses

Thickness is dependent on material layer selection.



Material Options

The layouts shown are a summation of individual units. Individual units may be assembled in various arrangements to dictate the larger design. Configurations shown are suggested, but can be rearranged to achieve a custom layout.

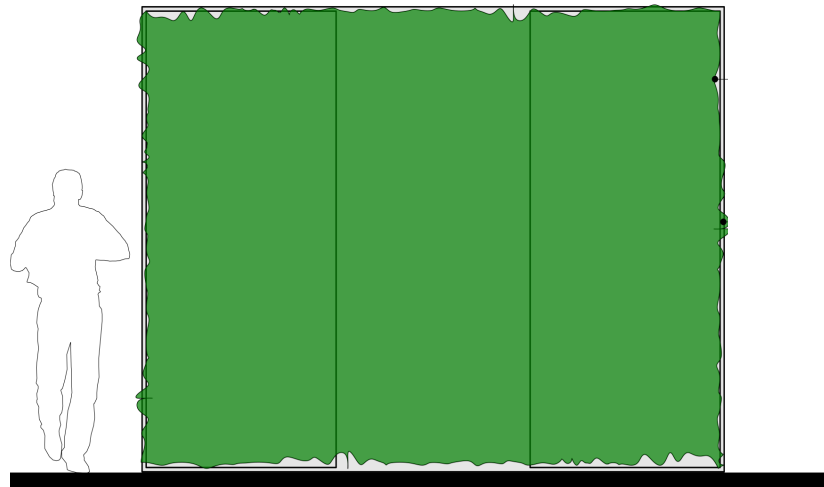

Reindeer Moss
1"-1.5" Depth



Mood Moss
2"-3" Depth



Sheet Moss
1"-1.25" Depth



Pole Moss
2"-2.25" Depth

Backer Options

Soundcore®

Our recycled PET felt creates an acoustic barrier, defending against wandering white noise and irritating echoes.

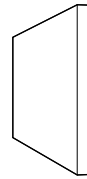

Single Layer
½" Thickness

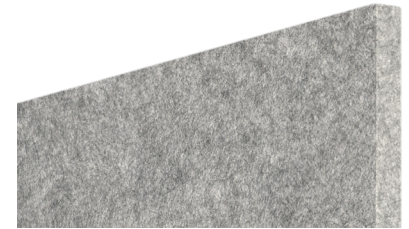

Wood treated plywood 1/2"

Ideal for recessed wall opportunities & and Pre-Manufacture Solutions



Single Layer
½" Thickness



Design Options + cost

The layouts shown are a summation of individual units. Individual units may be assembled in various arrangements to dictate the larger design. Configurations shown are suggested, but can be rearranged to achieve a custom layout.



Full Panel Integration

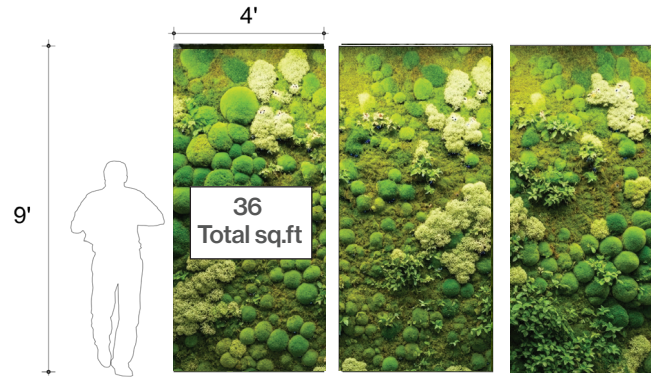

Individual Panel Coverage

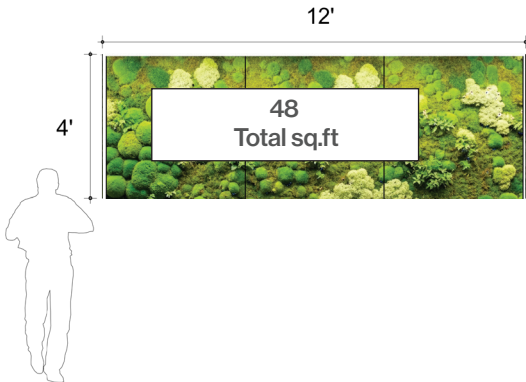

Upper Wall Option

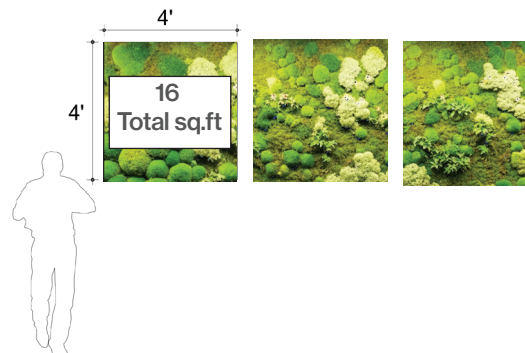

Upper Wall Individual Option

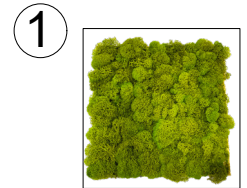

Reindeer Moss

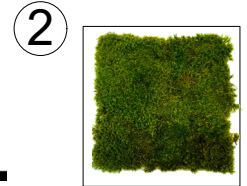

Mood Moss



Pole Moss

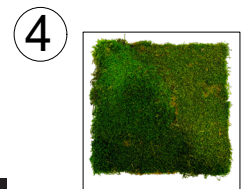

Sheet Moss

Installation Options*

All products and installation methods can be **customized** to meet the unique requirements of your space.

Adhesive Direct Advantages

Attachment solution using an adhesive to apply directly to an existing surface or substrate.

- + Fastest installation time
- + No gap between target surface and product
- + Lowest profile installation option
- + Easiest to install
- + Most versatile installation option

Available methods: Construction Adhesive, Peel & Stick, Custom

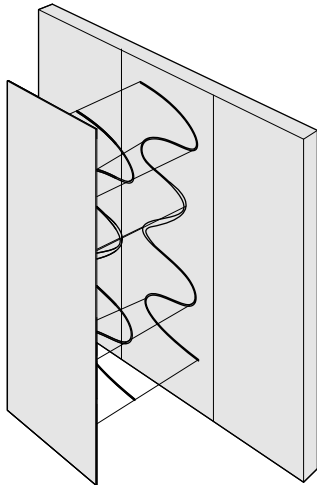

Mechanical Direct Advantages

Attachment solution using physical hardware to attach to an existing surface or substrate.

- + No clamping or dry time necessary
- + Easy to remove and does not damage the substrate when removed
- + Most appropriate installation solution for heavier products
- + Provides an opportunity for an air gap, which can increase the acoustic value of a product

Available methods: Z-Clips, Panel Clips, Standoffs, Screw & Washer, Magnet, Custom

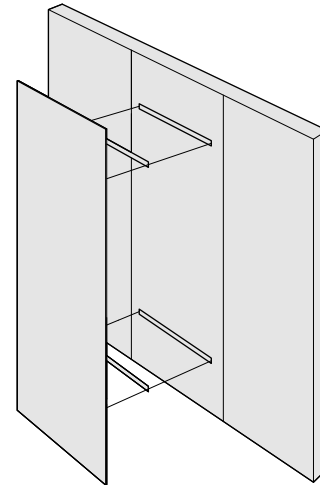

*Not all listed attachment methods may be applicable to this product.

Soundcore® Backer | 1/2"



SND130
Buckskin

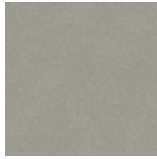

SND131
Abalone

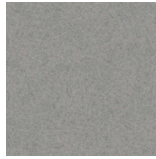

SND125
Chinchilla

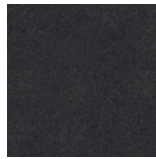

SND103
Storm Cloud



SND038
Inkwell



SND122
Briquette

Preserved Reindeer Moss Color Selection



Light Green
PMC#RD01LG



Medium Green
PMC#RD01MG



Nature Green
PMC#RD01NG



Forest Green
PMC#RD01FG



Lime Green
PMC#RD01LG



Cream
PMC#RD01CR



Black
PMC#RD01BK



Purple
PMC#RD01PR



Fuchsia
PMC#RD01FS



Red
PMC#RD01RD



Orange
PMC#RD01OR



Yellow
PMC#RD01YW

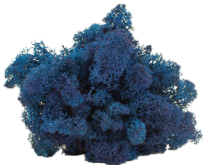

Royal Blue
PMC#RD01RB

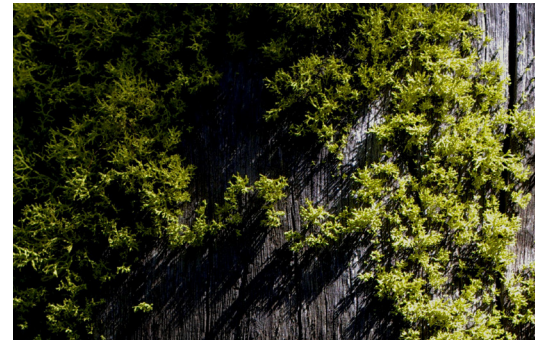

Why Moss?

Being surrounded by moss evokes the feeling of walking through a misty Rainforest enveloped by trees. Its velvety texture blanketing the forest floor creates a comforting environment. Incorporating biophilic design by including moss into interior spaces creates a bridge between the natural and built world.